

## Castors with steel bracket

### ESD cast polyurethane coating

#### COVERING

Mould-on polyurethane, hardness 90 Shore A, dark grey, anti-trace.  
Electrical resistivity  $< 10^9 \Omega$ .

#### WHEEL CENTRE BODY

Pressure die-cast aluminium.

#### ROLLING ACTION

Hub with shielded ball bearings.  
Ideal solution for heavy loads and continuous moving.

#### FIXED PLATE BRACKET

Zinc-plated steel sheet, the bracket is designed to withstand loads up to 3000N.

#### TURNING PLATE BRACKET

Zinc-plated steel sheet, the bracket is designed to withstand loads up to 3000N.

The presence of a double ball race and direct contact between the plate and the ball race ring with built-in pin ensure excellent manoeuvrability.

Does not require maintenance.

It consists of (see Fig.1):

1. fitting plate: electrolytically zinc-plated steel plate;
2. fork: electrolytically zinc-plated steel plate;
3. ball race ring: electrolytically zinc-plated steel plate;
4. central pin: incorporated in the plate, cold re-flanged;
5. rotation system: dual grease-lubricated ball race;
6. dust seal: RAL 7015 dark grey technopolymer.

#### BRAKE

Total brake that locks the wheel and bracket rotation.

The optimised dimensions and the retractible pedal ensure minimal space occupied and maximum actuation ease.

Hardened carbon steel spring.

The trolley must be turned to use the device.

The brake is simple and effective to use: it is actuated and released by a simple action from the top downward at the tip of two separate pedals, thus ensuring the utmost manoeuvring comfort.

#### STANDARD EXECUTIONS

- **PSL-N-ESD**: fixed plate bracket, without brake.
- **SSL-N-ESD**: turning plate bracket, without brake.
- **SSF-N-ESD**: turning plate bracket, with brake.
- **FSL-N-ESD**: turning plate bracket and centre pass-through hole, without brake.
- **FSF-N-ESD**: turning plate bracket and centre pass-through hole, with brake.

#### APPLICATIONS

Excellent rolling resistance and elasticity features, high wear and tearing resistance.

For further information see wheel technical data sheet RE.F5-ESD (see page -).

#### FEATURES AND APPLICATIONS

The special polyurethane with electrical resistivity  $< 10^9 \Omega$  prevents the accumulation of electrostatic charge. RE.F5-N-ESD wheels are therefore suitable for applications in "ESD PROTECTED AREAS" where all components sensitive to electrostatic discharges must be treated with the minimum risk of damage.

The electrical specifications meet the requirements of the ISO 22878:2004 standard. The electrical resistivity values indicated have been measured in the temperature range 18-25°C (as per regulations). For environments with operating temperatures below 10°C, contact ELESA sales service.

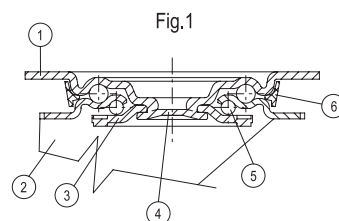
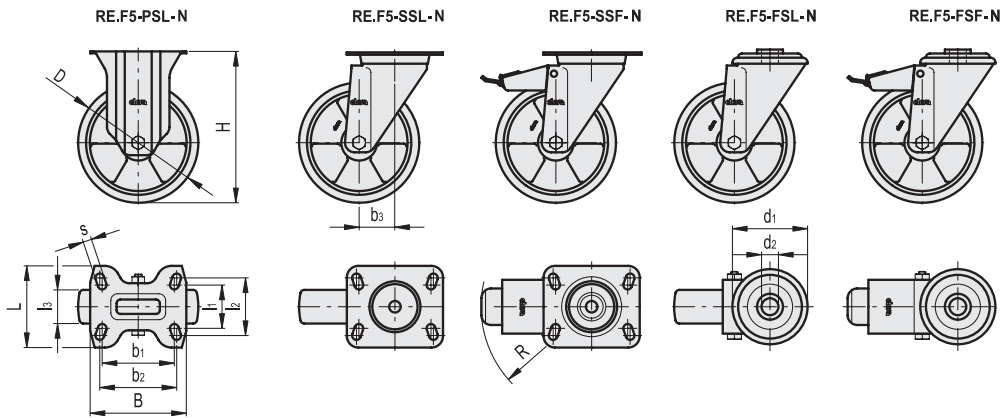

Fig.1



Code	Description	D	d1	d2	l1	l2	l3	H	B	L	s	b1	b2	b3	R	Rolling resistance# [N]	Dynamic carrying capacity# [N]	
451651-ESD	RE.F5-080-PSL-N-ESD	80	-	-	45	60	25	107	100	85	9	75	80	-	-	1500	1700	520
451656-ESD	RE.F5-100-PSL-N-ESD	100	-	-	45	60	30	128	100	85	9	75	80	-	-	2250	2000	690
451661-ESD	RE.F5-125-PSL-N-ESD	125	-	-	45	60	35	156	100	85	9	75	80	-	-	2800	2200	890
451666-ESD	RE.F5-150-PSL-N-ESD	150	-	-	73	87	40	194	140	110	11	105	105	-	-	3300	3000	2040
451671-ESD	RE.F5-200-PSL-N-ESD	200	-	-	73	87	50	240	140	110	11	105	105	-	-	3600	3000	2760
451551-ESD	RE.F5-080-SSL-N-ESD	80	-	-	45	60	25	107	100	85	9	75	80	39	-	1500	1700	720
451556-ESD	RE.F5-100-SSL-N-ESD	100	-	-	45	60	30	128	100	85	9	75	80	35	-	2250	2000	940
451561-ESD	RE.F5-125-SSL-N-ESD	125	-	-	45	60	35	156	100	85	9	75	80	37	-	2800	2200	1140
451565-ESD	RE.F5-150-SSL-N-ESD	150	-	-	73	87	40	194	140	110	11	105	105	56	-	3300	3000	2340
451571-ESD	RE.F5-200-SSL-N-ESD	200	-	-	73	87	50	240	140	110	11	105	105	56	-	3600	3000	3050
451601-ESD	RE.F5-080-SSF-N-ESD	80	-	-	45	60	25	107	100	85	9	75	80	39	120	1500	1700	910
451606-ESD	RE.F5-100-SSF-N-ESD	100	-	-	45	60	30	128	100	85	9	75	80	35	120	2250	2000	1080
451611-ESD	RE.F5-125-SSF-N-ESD	125	-	-	45	60	35	156	100	85	9	75	80	37	120	2800	2200	1280
451615-ESD	RE.F5-150-SSF-N-ESD	150	-	-	73	87	40	194	140	110	11	105	105	56	156	3300	3000	2630
451621-ESD	RE.F5-200-SSF-N-ESD	200	-	-	73	87	50	240	140	110	11	105	105	56	156	3600	3000	3250
451851-ESD	RE.F5-080-FSL-N-ESD	80	73	12	-	-	25	107	-	-	-	-	-	39	-	1500	1700	650
451856-ESD	RE.F5-100-FSL-N-ESD	100	73	12	-	-	30	128	-	-	-	-	-	35	-	2250	2000	880
451861-ESD	RE.F5-125-FSL-N-ESD	125	73	12	-	-	35	156	-	-	-	-	-	37	-	2800	2200	1080
451866-ESD	RE.F5-150-FSL-N-ESD	150	102	20	-	-	40	194	-	-	-	-	-	56	-	3300	3000	2200
451871-ESD	RE.F5-200-FSL-N-ESD	200	102	20	-	-	50	240	-	-	-	-	-	56	-	3600	3000	2950
451901-ESD	RE.F5-080-FSF-N-ESD	80	73	12	-	-	25	107	-	-	-	-	-	39	120	1500	1700	780
451906-ESD	RE.F5-100-FSF-N-ESD	100	73	12	-	-	30	128	-	-	-	-	-	35	120	2250	2000	1020
451911-ESD	RE.F5-125-FSF-N-ESD	125	73	12	-	-	35	156	-	-	-	-	-	37	120	2800	2200	1230
451916-ESD	RE.F5-150-FSF-N-ESD	150	102	20	-	-	40	194	-	-	-	-	-	56	156	3300	3000	2490
451921-ESD	RE.F5-200-FSF-N-ESD	200	102	20	-	-	50	240	-	-	-	-	-	56	156	3600	3000	3240

# For rolling resistance and dynamic carrying capacity see Technical data (on page -).

